

COMPACT SILENCE ECO+

107

02.14

SFA



SANICOMPACT® Silence ECO+

FR NOTICE D'INSTALLATION

UK INSTALLATION INSTRUCTIONS

DE INSTALLATIONSHINWEISE

IT STRUZIONI PER L'INSTALLAZIONE

ES MANUAL DE INSTALACIÓN

PT MANUAL DE INSTALAÇÃO

NL INSTALLATIE VOORSCHRIFTEN

SE INSTALLATIONSANVISNING

DK INSTALLATIONSVEJLEDNING

NO INSTALLASJONSANVISING

FI ASENNUSOHJEET

HU FELSZERELÉSI ÉS KEZELÉSI ÚTMUTATÓ

PL INSTRUKCJA INSTALACJI

RU ИНСТРУКЦИЯ ПО МОНТАЖУ И ЭКСПЛУАТАЦИИ

RO MANUAL DE INSTALARE

CZ NÁVOD K INSTALACI A POUŽÍVÁNÍ

TR KURULUM KILAVUZU

EL ΟΔΗΓΙΕΣ ΕΓΚΑΤΑΣΤΑΣΗΣ

CN 用户应保留安装指南以备用

KR 설치내용서

CE

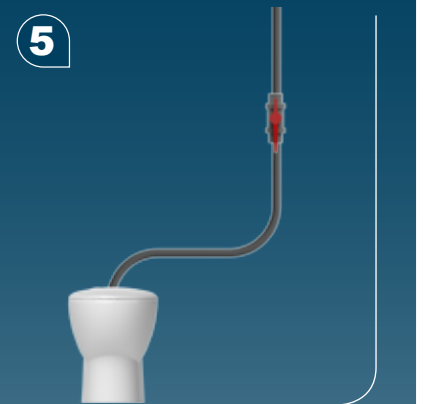
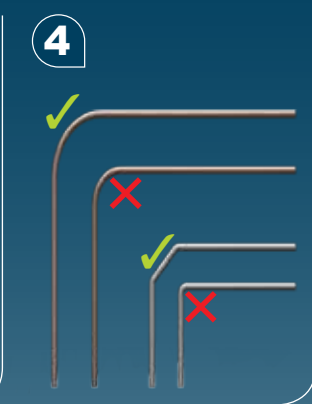
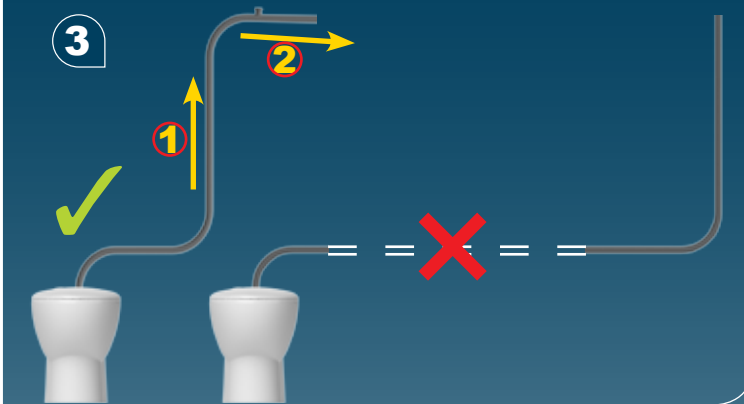
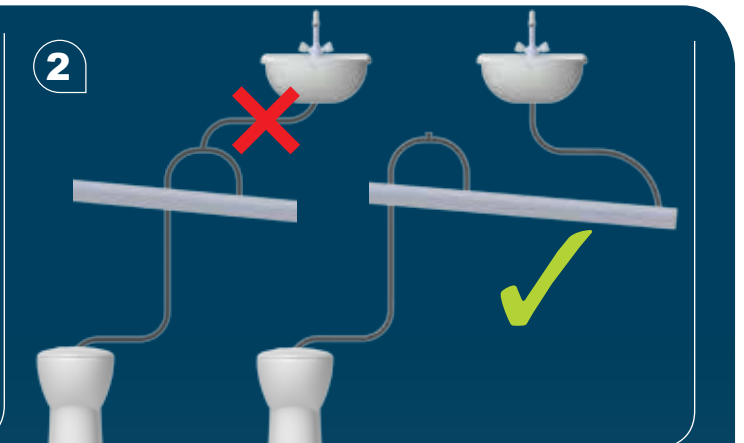
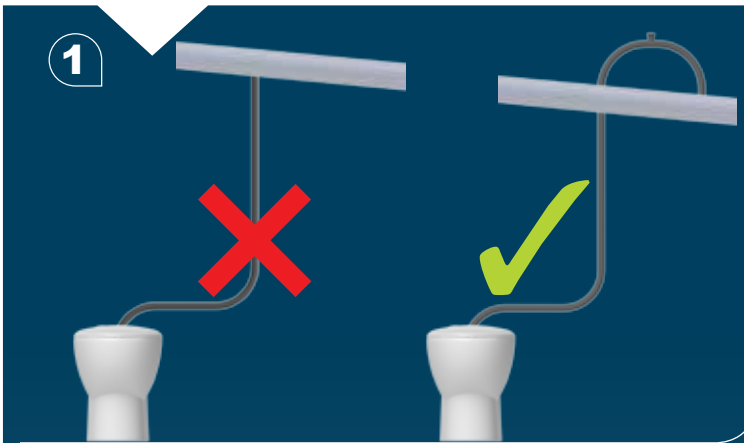
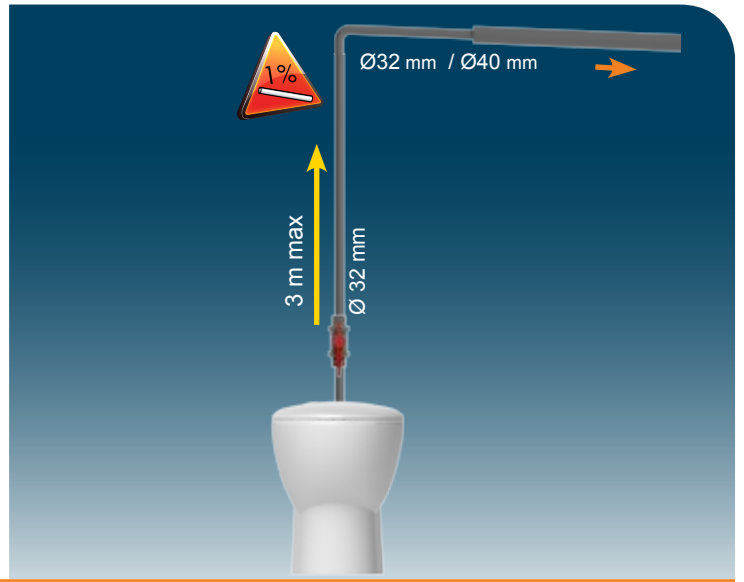

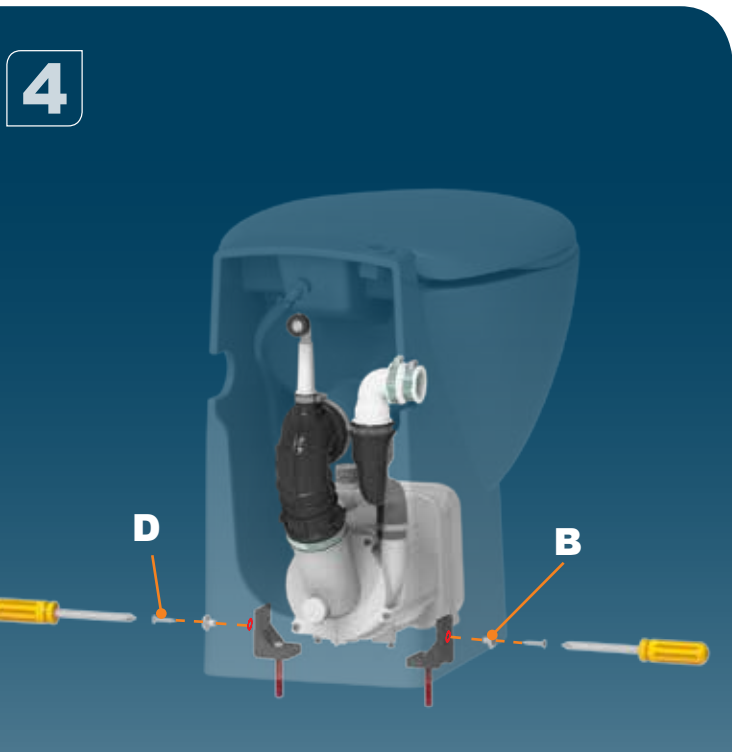
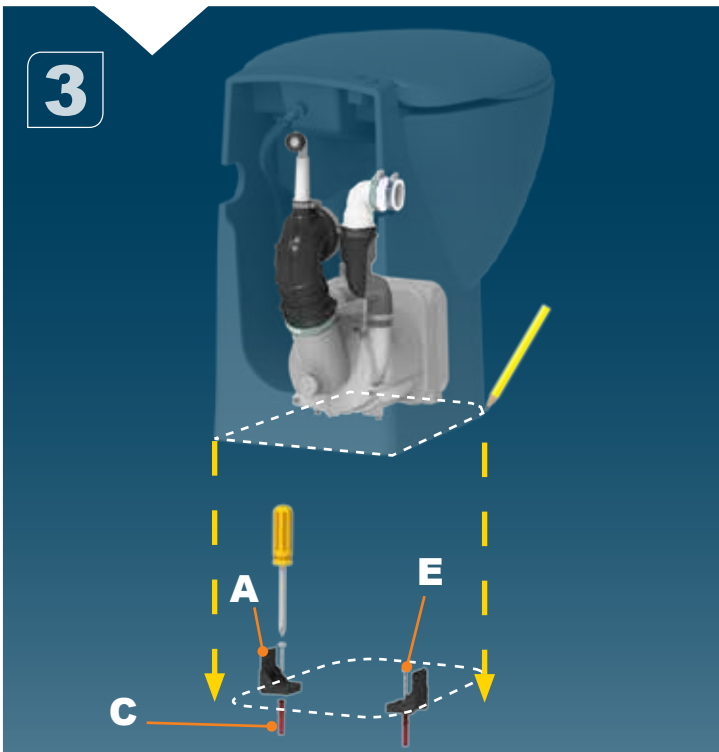
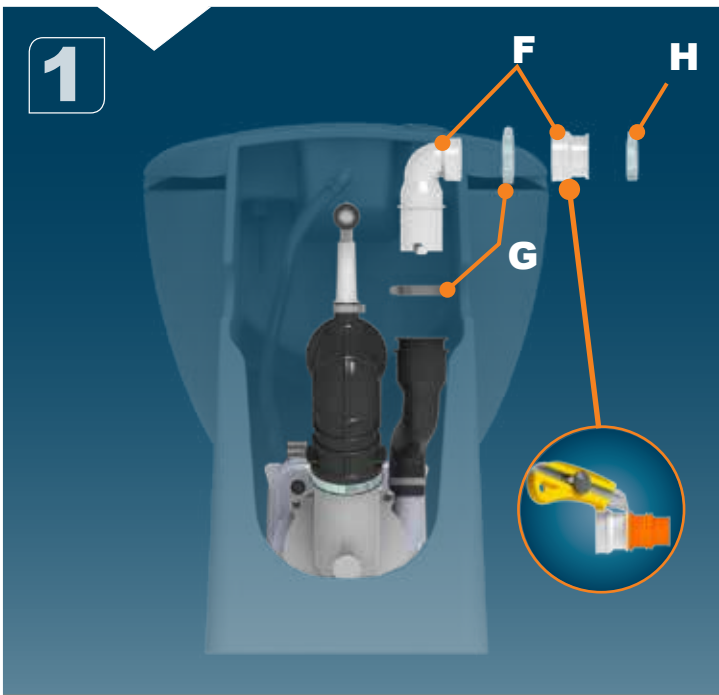
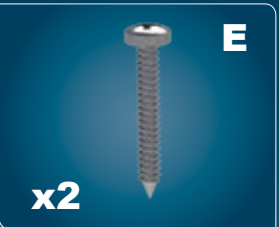
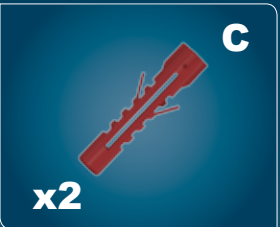
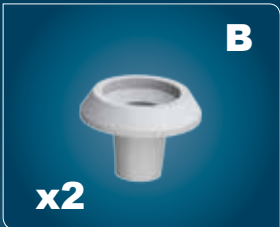

5



7



6

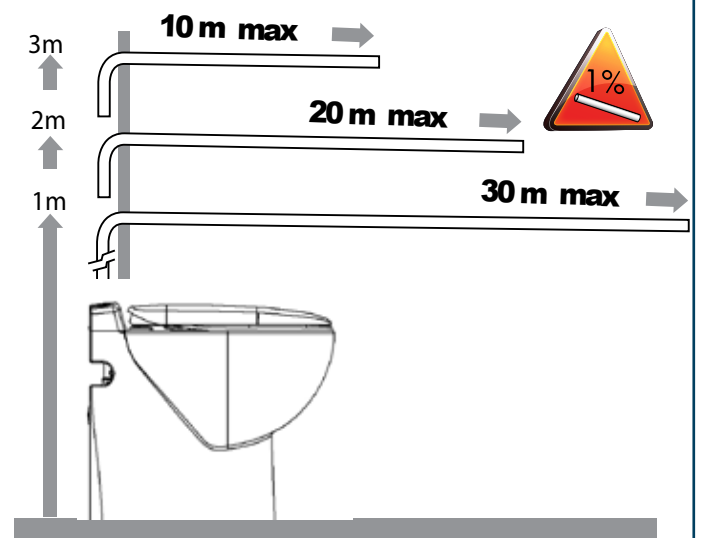
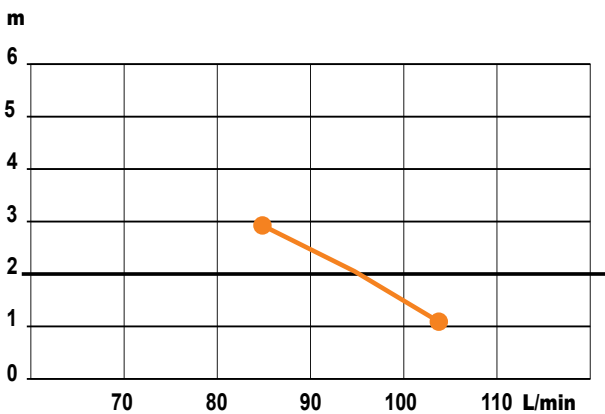
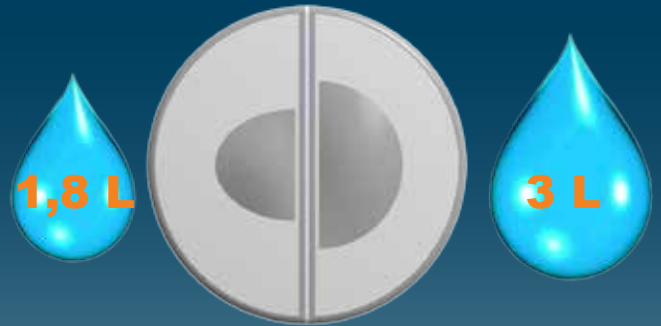
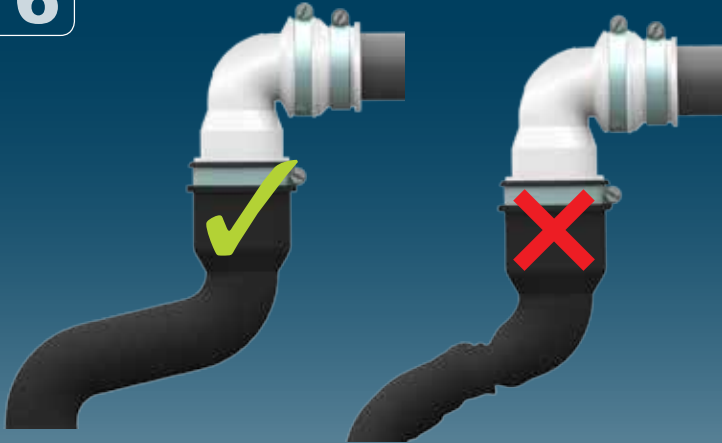

SANICOMPACT SILENCE ECO+
CR15 DF

220-240 V - 50 Hz - 2,5 A - 550 W - IP44 - ⚡





SANICOMPACT® PRO
SILENCE ECO+ code: C11



SANICOMPACT® ELITE
SILENCE ECO+ code: C6



SANICOMPACT® LUXE
SILENCE ECO+ code: C3



SANICOMPACT 43®
SILENCE ECO+ code: C43



SANICOMPACT® 48
SILENCE ECO+ code: C48



SANICOMPACT® C4
SILENCE ECO+ code: C4

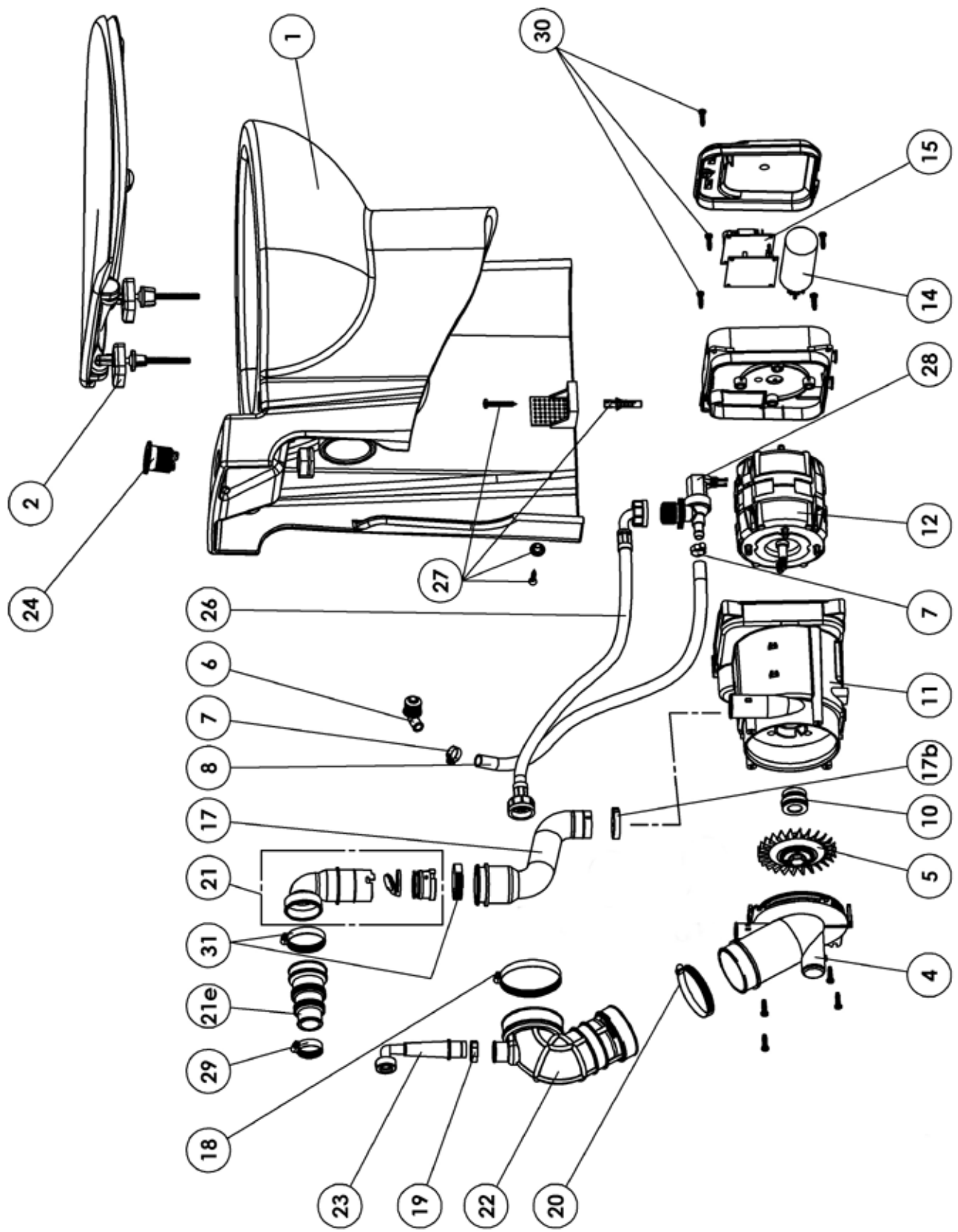

FRANCE**SOCIÉTÉ FRANÇAISE
D'ASSAINISSEMENT**

8, rue d'Aboukir - 75002 Paris
Tél. +33 1 44 82 39 00
Fax +33 1 44 82 39 01

UNITED KINGDOM**SANIFLO Ltd.,**

Howard House, The Runway
South Ruislip Middx.,
HA4 6 SE
Tel. +44 208 842 0033/4040
Fax +44 208 842 1671

IRELAND**SANIRISH Ltd**

IDA Industrial Estate
Edenderry - County Offaly
Tel. + 353 46 9733 102
Fax + 353 46 97 33 093

AUSTRALIA**SANIFLO AUSTRALIA**

Unit 9/10, 25 Gibbes Street Pty Ltd
Chatswood NSW 2067
Tel. +61 298 826 200
Fax +61 298 826 950

DEUTSCHLAND**SFA SANIBROY GmbH**

Waldstr. 23 Geb. B5 - 63128
Dietzenbach CH-8954
Tel. (060 74) 30928-0
Fax (060 74) 30928-90

ITALIA**SFA ITALIA spa**

Via del Benessere, 9
27010 Siziano (PV)
Tel. 03 82 61 81
Fax 03 82 61 8200

ESPAÑA**GRUPO SFA**

C/ Vinyalets, 1 - Pl. Can Vinyalets
08130 Sta. - Perpètua de Mogoda -
Barcelona
Tel. +34 93 544 60 76
Fax +34 93 462 18 96

PORTUGAL**SFA, Lda.**

Sintra Business Park, ed.01-1ºP
2710-089 SINTRA
Tel. +351 219 112 785
Fax +351 219 577 000

РОССИЯ**SFA РОССИЯ**

101000 Москва - Колпачный пер.
9а,
Тел. (495) 258 29 51
факс (495) 258 29 51

SUISSE SCHWEIZ SVIZZERA**SFA SANIBROY AG**

Vorstadt 4
3380 Wangen a. A.
Tel. +41 (0)32 631 04 74
Fax +41 (0)32 631 04 75

BENELUX**SFA BENELUX B.V.**

Voltaweg 4
6101 XK Echt
Tel. +31 475 487100
Fax +31 475 486515

SVERIGE**SANIFLO AB**

BOX 797
S-191 27 Sollentuna
Tel. +08-404 15 30
info@saniflo.se

POLSKA**SFA POLAND**

ul. Kolejowa 33
05-092 Łomianki/Warszawa
Tel. (+4822) 732 00 32
Fax (+4822) 751 35 16

CHINA**SFA 中国**

上海市静安区石门二路333弄3号振安
广场恒安大厦27C室 (200041)
T: +86(0)21 6218 8969
F: +86(0)21 6218 8970

ČESKÁ REPUBLIKA**SFA-SANIBROY, spol. s r.o**

Na Košince - 180 00 PRAHA 8 - Libeň
Tel. +420 266 712 855
Fax +420 266 712 856

ROMANIA**SFA SANIFLO S.R.L.**

Strada Leonard Nicolae, nr. 2A
Timișoara 300454
Tel. +40 256 245 092
Fax +40 256 245 029

TÜRKIYE**SFA SANIHYDRO LTD STI**

Mecidiye Cad No:36-B Sevenscan Apt
34387 ISTANBUL Mecidiyeköy
Tel. +90 212 275 30 88
Fax, +90 212 275 90 58

KOREA**www.SFA.biz**

sales@saniflo-korea.kr

SERVICE HELPLINES

	TEL	FAX	TEL	FAX
France	N°Azur 0 810 05 90 02 <small>1 UT par appel</small>	03 44 94 46 19	Benelux	+31 475 487100
United Kingdom	08457 650011 (Call from a land line)	020 8842 1671	Sverige	+08-404 15 30
Ireland	1850 23 24 25 (LOW CALL)	+ 353 46 97 33 093	Norge	+08-404 15 30
Australia	+61 298 826 200	+61 298 826 950	Polska	(+4822) 732 00 33
Deutschland	0800 82 27 82 0	(060 74) 30928-90	Россия	(495) 258 29 51
Italia	0382 6181	+39 0382 618200	Česká Republika	+420 266 712 855
España	+34 93 544 60 76	+34 93 462 18 96	România	+40 256 245 092
Portugal	+351 219 112 785	+351 219 577 000	Türkiye	+90 212 275 30 88
Suisse Schweiz Svizzera	+41 44 748 17 44	+41 44 748 17 43	中国	+86(0)21 6218 8969
				+86(0)21 6218 8970

Service information : www.sfa.biz